

# A160F13125TF

Terasaki TemBreak PRO MCCB 160 Frame 36kA 3P 125A Adj.  
Thermal Fix. Magnetic



<b>Component type</b>	Power switching circuit breaker
<b>Range</b>	TemBreak PRO
<b>Model</b>	N/A
<b>Product status</b>	Existing

The latest innovation of MCCBs from Terasaki, offering superior performance and versatility.

<b>Rated current <math>I_n</math></b>	125.0 A
<b>Number of poles</b>	3.0
<b>Max. rated operation voltage <math>U_e</math> AC</b>	690.0 V
<b>Rated ultimate short-circuit breaking capacity <math>I_{cu}</math> at 415 V, 50 Hz</b>	36.0 kA
<b>Rated service short-circuit breaking capacity <math>I_{cs}</math> at 415 V, 50 Hz</b>	20.0 kA
<b>Type of protection trip unit</b>	Thermal/magnetic release
<b>Trip curve</b>	Adj. thermal, fixed magnetic
<b>Frame size rating</b>	160.0 A
<b>Long time overload protection adjustment range</b>	80 - 125 A
<b>Position of connection for main current circuit</b>	Front side
<b>Rated frequency</b>	50 - 60 Hz
<b>Rated insulation voltage <math>U_i</math></b>	690.0 V
<b>Suitable for isolation</b>	Yes
<b>Rated short circuit breaking capacity, <math>I_{cu}</math> 690V AC</b>	6.0 kA
<b>Rated short circuit breaking capacity, <math>I_{cs}</math> 690V AC</b>	3.0 kA
<b>Rated impulse withstand voltage <math>U_{imp}</math></b>	8.0 kV
<b>Over voltage category</b>	IV
<b>Reverse connection of supply possible</b>	Yes
<b>AC power loss per pole at <math>I_n</math></b>	10.9 W
<b>Electrical life at <math>U_n, I_n</math> (service cycles)</b>	10000.0 cycles
<b>Type of electrical connection of main circuit</b>	Screw connection
<b>Power loss at rated current</b>	32.8 W
<b>Connectable conductor cross section</b>	1.5 - 70 mm <sup>2</sup>

## ELECTRICAL

## MECHANICAL

# A160F13125TF

Terasaki TemBreak PRO MCCB 160 Frame 36kA 3P 125A Adj.  
Thermal Fix. Magnetic



**TERASAKI**  
Innovators in Protection Technology

<b>MECHANICAL</b>	DIN rail (top hat rail) mounting optional	Yes
	Mechanical life (service cycles)	20000.0 cycles
	Vibration acceleration (Max)	19.0 m/s <sup>2</sup>
	Vibration frequency, operational (Max)	16.7 Hz
	Vibration duration (Max)	12.0 min
<b>DIMENSIONS</b>	Height	130.0 mm
	Width	75.0 mm
	Pole connection pitch	25.0 mm
	Built-in depth	68.0 mm
	Depth (toggle included)	95.0 mm
	Weight	0.8 kg
<b>ENVIRONMENT</b>	Pollution degree	3.0
	Rated surrounding temperature without derating	50.0 °C
	Ambient temperature during operating	-5 - 70 °C
	Max. temperature	70.0 °C
	Storage temperature	-10 - 70 °C
	Allowable relative humidity	0 - 85 %
	Altitude before derating (Max)	2000.0 m
<b>CERTIFICATES/APPROVALS</b>	Standard	AS/NZS IEC 60947.2

# A160F13125TF

Terasaki TemBreak PRO MCCB 160 Frame 36kA 3P 125A Adj.  
Thermal Fix. Magnetic



## DIMENSIONAL DIAGRAM

Front Connected

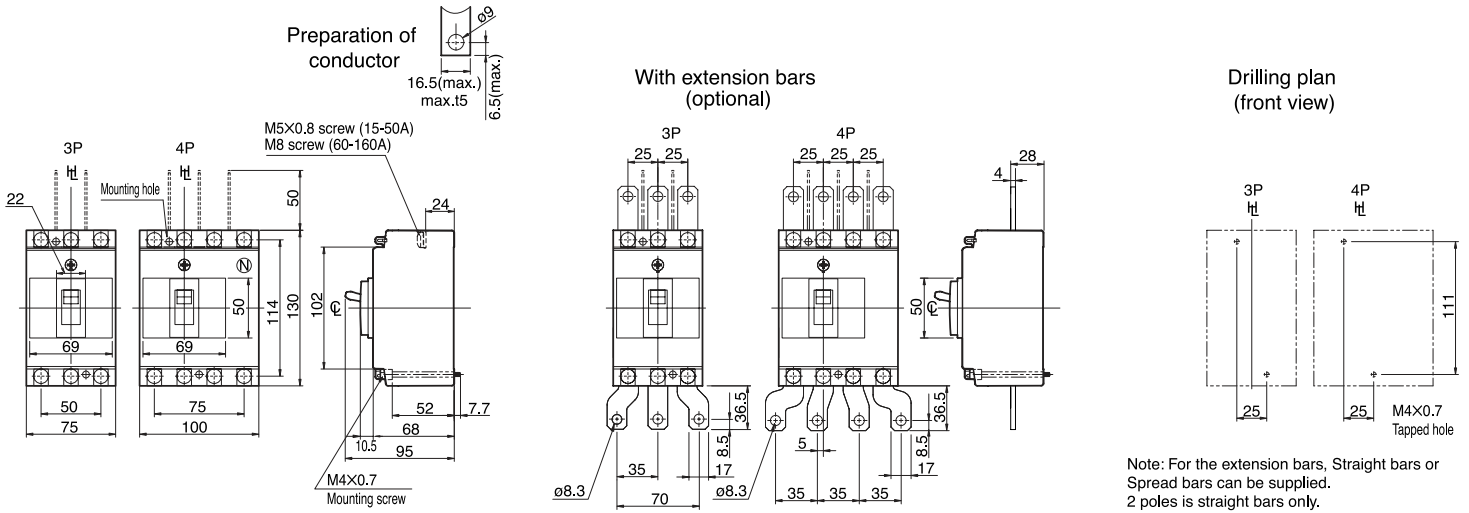

Rear Connected

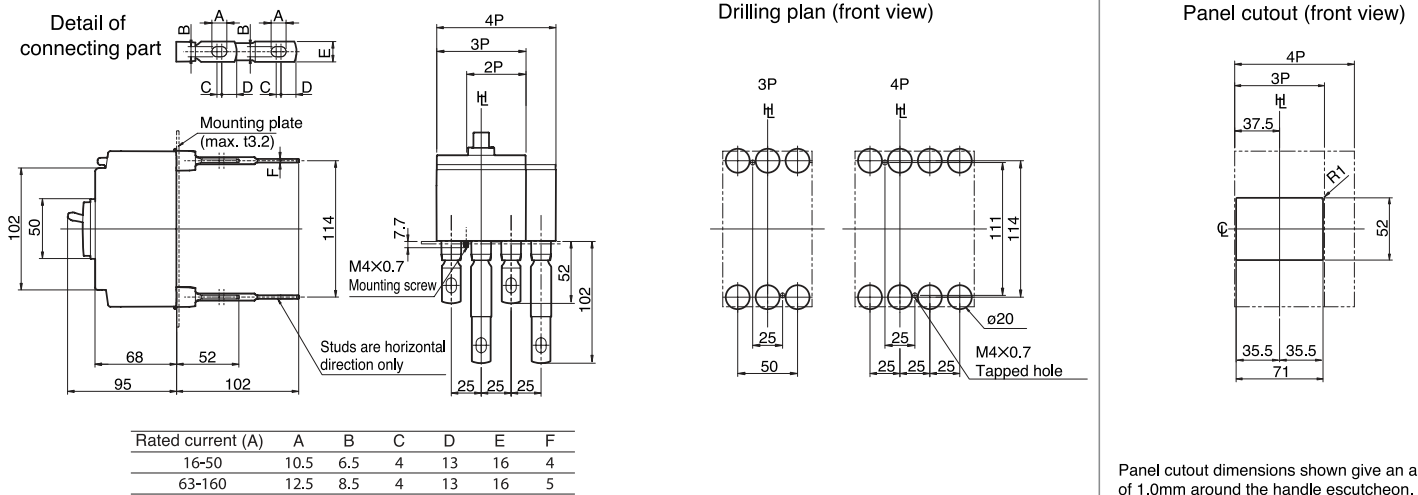

## RELATED PRODUCTS

### ACCESSORY



Item No: DTPF12

Required: No

Description: NHP DIN-T Accessory Pole Filler 12Pole Strip 216mm equals 24 x 9mm Segments



Item No: T2AL00LML3STA

Required: No

Description: Terasaki TemBreak PRO Alarm Switch for A and P Models 1 CO Contact Left Side Mounting General Type

# A160F13125TF

Terasaki TemBreak PRO MCCB 160 Frame 36kA 3P 125A Adj.  
Thermal Fix. Magnetic



## RELATED PRODUCTS

### ACCESSORY

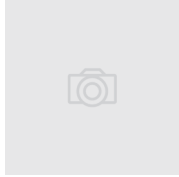

**Item No:** T2AL00LML3SWA

**Required:** No

**Description:** Terasaki TemBreak PRO Alarm Switch for A and P Models 1 CO Contact Left Side Mounting Wired Type



**Item No:** T2AX00LML3RWA

**Required:** No

**Description:** Terasaki TemBreak PRO Auxiliary Switch for A and P Models 1 CO Contact Micro Switch Wired Type



**Item No:** T2AX00LML3STA

**Required:** No

**Description:** Terasaki TemBreak PRO Auxiliary Switch for A and P Models 1 CO Contact General Type



**Item No:** T2AX00LML3SWA

**Required:** No

**Description:** Terasaki TemBreak PRO Auxiliary Switch for A and P Models 1 NO Contact 1 NC Contact Wired Type



**Item No:** T2BA16L3SH

**Required:** No

**Description:** Terasaki TemBreak PRO Interpole Barriers for A160/P160 Qty 2



**Item No:** T2CF16L1SLHP

**Required:** No

**Description:** Terasaki TemBreak PRO Terminal Cover CF Long Style for 1P A160 MCCB Qty 1



**Item No:** T2CF16L3SLHP

**Required:** No

**Description:** Terasaki TemBreak PRO Terminal Cover CF Long Style for 3P A160 MCCB Qty 1

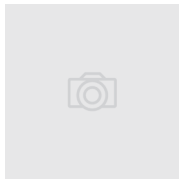

**Item No:** T2CF16L3SSHP

**Required:** No

**Description:** Terasaki TemBreak PRO Terminal Cover CF Short Style for 3P A160 MCCB Qty 1



**Item No:** T2CF16L3SWHP

**Required:** No

**Description:** Terasaki TemBreak PRO Terminal Cover CF Wide Style for 3P A160 MCCB Qty 1



**Item No:** T2CF16L4SWHP

**Required:** No

**Description:** Terasaki TemBreak PRO Terminal Cover CF Wide Style for 4P A160 MCCB Qty 1

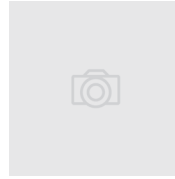

**Item No:** T2CF16LL

**Required:** No

**Description:** Terasaki TemBreak PRO Terminal Cover Clip for A160



**Item No:** T2CR12L3SHP

**Required:** No

**Description:** Terasaki TemBreak PRO Terminal Cover CR Flush Style for A160 3P MCCB Qty 1



**Item No:** T2CR12L3SP

**Required:** No

**Description:** Terasaki TemBreak PRO Terminal Cover CR Flush Style for A160 3P MCCB Qty 2

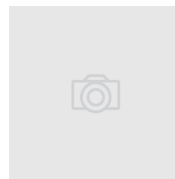

**Item No:** T2CR12L4SHP

**Required:** No

**Description:** Terasaki TemBreak PRO Terminal Cover CR Flush Style for A160 4P MCCB Qty 1

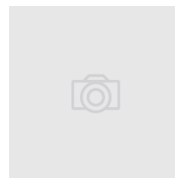

**Item No:** T2CR12L4SP

**Required:** No

**Description:** Terasaki TemBreak PRO Terminal Cover CR Flush Style for A160 4P MCCB Qty 2

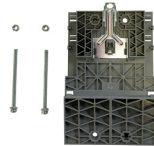

**Item No:** T2DA16L

**Required:** No

**Description:** Terasaki TemBreak PRO DIN Rail Adaptor for A160 MCCB



**Item No:** T2FB12L3SB

**Required:** No

**Description:** Terasaki TemBreak PRO Straight Extension Bars 3P A160 MCCB Qty 6

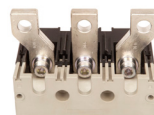

**Item No:** T2FB12L4SB

**Required:** No

**Description:** Terasaki TemBreak PRO Straight Extension Bars 4P A160 MCCB Qty 8

# A160F13125TF

Terasaki TemBreak PRO MCCB 160 Frame 36kA 3P 125A Adj.  
Thermal Fix. Magnetic



## RELATED PRODUCTS

### ACCESSORY



**Item No:** T2FB16L3WB

**Required:** No

**Description:** Terasaki TemBreak PRO Flanged Extension Bars 3P A160 MCCB Qty 6



**Item No:** T2RP12L3SA

**Required:** No

**Description:** Terasaki TemBreak PRO Rear Connect Studs for 3P A160 MCCB



**Item No:** T2FB16L4WB

**Required:** No

**Description:** Terasaki TemBreak PRO Flanged Extension Bars 4P A160 MCCB Qty 8

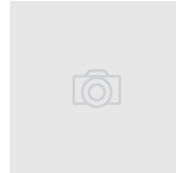

**Item No:** T2RP12L4SA

**Required:** No

**Description:** Terasaki TemBreak PRO Rear Connect Studs for 4P A160 MCCB



**Item No:** T2HB16LUR5BNP

**Required:** No

**Description:** Terasaki TemBreak PRO Handle Direct Mount with Door Interlock for A160 Black

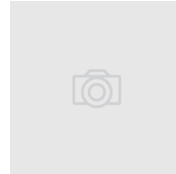

**Item No:** T2SH00LA10T

**Required:** No

**Description:** Terasaki TemBreak PRO Shunt Trip for A/P Models 110V AC



**Item No:** T2HB16LUR5RNP

**Required:** No

**Description:** Terasaki TemBreak PRO Handle Direct Mount with Door Interlock for A160 Red



**Item No:** T2SH00LA10WA

**Required:** No

**Description:** Terasaki TemBreak PRO Shunt Trip for A/P Models 110-120V AC Wired Type



**Item No:** T2HL25L

**Required:** No

**Description:** Terasaki TemBreak PRO Non Captive Toggle Lock 5 x 16.5mm Slot for A160/A250/P160/P250

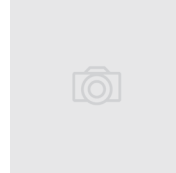

**Item No:** T2SH00LA20T

**Required:** No

**Description:** Terasaki TemBreak PRO Shunt Trip for A/P Models 230-240V AC



**Item No:** T2HP16LR6BN

**Required:** No

**Description:** Terasaki TemBreak 2 Handle Square IP65 for Lite 160 MCCBs Grey/Black

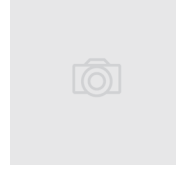

**Item No:** T2SH00LA40T

**Required:** No

**Description:** Terasaki TemBreak PRO Shunt Trip for A/P Models 400-415V AC

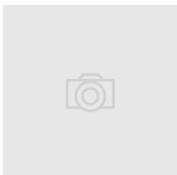

**Item No:** T2HP16LR6RN

**Required:** No

**Description:** Terasaki TemBreak 2 Handle Square IP54 for Lite 160A Red/Yellow



**Item No:** T2SH00LA40WA

**Required:** No

**Description:** Terasaki TemBreak PRO Shunt Trip for A/P Models 380-450V AC Wired Type



**Item No:** T2HS250SHAFT

**Required:** No

**Description:** Terasaki TemBreak 2 Handle Shaft 90mm for 125/250 MCCBs



**Item No:** T2SH00LD02T

**Required:** No

**Description:** Terasaki TemBreak PRO Shunt Trip for A/P Models 24V DC



**Item No:** T2HSESC100

**Required:** No

**Description:** Terasaki TemBreak 2 Handle Label Plate 100mm MCCBs



**Item No:** T2SH00LD02WA

**Required:** No

**Description:** Terasaki TemBreak PRO Shunt Trip for A/P Models 24V DC Wired Type

# A160F13125TF

Terasaki TemBreak PRO MCCB 160 Frame 36kA 3P 125A Adj.  
Thermal Fix. Magnetic



## RELATED PRODUCTS

### ACCESSORY



**Item No:** T2SH00LD04WA

**Required:** No

**Description:** Terasaki TemBreak PRO Shunt Trip for A/P Models 48V DC Wired Type



**Item No:** T2SH00LD10WA

**Required:** No

**Description:** Terasaki TemBreak PRO Shunt Trip for A/P Models 110-120V DC Wired Type



**Item No:** T2SH00LD20WA

**Required:** No

**Description:** Terasaki TemBreak PRO Shunt Trip for A/P Models 200-240V DC Wired Type



**Item No:** T2UV00LA10NWA

**Required:** No

**Description:** Terasaki TemBreak PRO Undervoltage Trip Instantaneous for A/P Models 100-120V AC Wired Type



**Item No:** T2UV00LA20NT

**Required:** No

**Description:** Terasaki TemBreak PRO Undervoltage Trip Instantaneous for A/P Models 230 to 240V AC



**Item No:** T2UV00LA20NWA

**Required:** No

**Description:** Terasaki TemBreak PRO Undervoltage Trip Instantaneous for A/P Models 200-240V AC Wired Type



**Item No:** T2UV00LA40NWA

**Required:** No

**Description:** Terasaki TemBreak PRO Undervoltage Trip Instantaneous for A/P Models 380-450V AC Wired Type

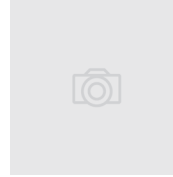

**Item No:** T2UV00LD02NT

**Required:** No

**Description:** Terasaki TemBreak PRO Undervoltage Trip Instantaneous for A/P Models 24V DC



**Item No:** T2UV00LD02NWA

**Required:** No

**Description:** Terasaki TemBreak PRO Undervoltage Trip Instantaneous for A/P Models 24V DC Wired Type



**Item No:** T2UV00LD10NWA

**Required:** No

**Description:** Terasaki TemBreak PRO Undervoltage Trip Instantaneous for A/P Models 100-120V DC Wired Type



**Item No:** T2UV00LD20NWA

**Required:** No

**Description:** Terasaki TemBreak PRO Undervoltage Trip Instantaneous for A/P Models 200-240V DC Wired Type



**Item No:** TPHS16LR5GM

**Required:** No

**Description:** Terasaki TemBreak PRO HS Handle with 356mm Extension Shaft IP55 for A160 MCCB Grey



**Item No:** TPHS16LR5RM

**Required:** No

**Description:** Terasaki TemBreak PRO HS Handle with 356mm Extension Shaft IP55 for A160 MCCB Red